

UR4A

4" Series Round Adjustable Trim



Project _____

Notes _____

Fixture Type _____

Date _____



UR4A-11 (illustrated)

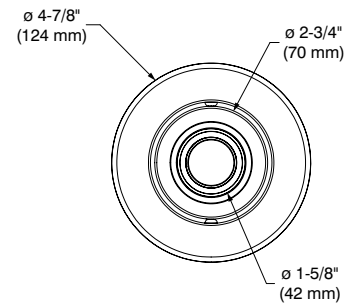
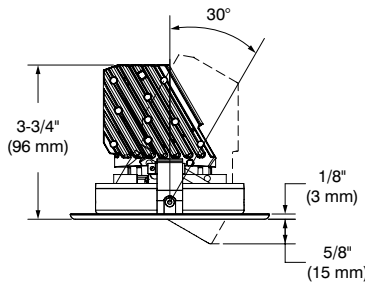

SPECIFICATIONS

LED MODULE

SOLID COLORS

Lumileds Luxeon CoB

2,700K - CRI: 80+

3,000K - CRI: 80+

2,700K - CRI: 90+

3,000K - CRI: 90+

3,500K - CRI: 90+

4,000K - CRI: 90+



Lumens Maintenance:

L_{70} @ 50,000 hours

Color Binning: 3 SDCM

LED MODULE (CONT'D)

WARM DIMMING (WD)

LED module mimicking the halogen lamp dimming conditions by lowering color temperature from 3,050K at full intensity down to 1,800K at low-end while ensuring 90+ CRI throughout the whole process.

Lumens Maintenance:

L_{70} @ 50,000 hours

Color Binning: 3 SDCM

DELIVERED LUMENS

Performance 1 (10W):

1,018 lumens @ 3,000K, 101.8 lms/W

Performance 2 (15W):

1,326 lumens @ 3,000K, 88.4 lms/W

Warm Dimming (WD)

650 lumens @ 3,000K, 43.3 lms/W

OPTIC SYSTEM*

Optical reflectors available:

Spot, Narrow Flood, Flood

Standard

Spot (S)	16°
Narrow Flood (M)	32°
Flood (L)	48°

* Average beams shown. Consult [ies files on our Website](#) for more details.

LENSES

Without lens (std)

Clear (C)

Frosted (F)

Honeycomb (H)

Linear (L)

Prismatic (P)

Solite (S)

POWER SUPPLY

(Determined by the choice of housing)

120V, 277V or 120V/277V

Several driver models available in two performances (10W and 15W) and in two dimming options (ELV and 0-10V).

See housing specification sheets for more details.

HEAT SINK

High quality aluminum injected heat sink ensuring maximum heat dissipation.

TRIM

Powder coat painted or plated die-formed steel. Tilt: up to 30°.

CEILING CUTOUT

ø 4-1/4" (108 mm)

UR4A

4" Series Round Adjustable Trim



SPECIFICATIONS (CONT'D)

COMPATIBLE HOUSINGS

	Remodel Housings	New Construction Housings	IC Housings
Performance 1 10W Warm Dimming not compatible	IC and Air Tight REUR4-120D1 REUR4-120E1 REUR4-277D1 REUR4-UV1	IC and Air Tight NWUR4-120D1 NWUR4-120E1 NWUR4-277D1 NWUR4-UV1 Emergency Driver Non-IC and Air Tight NWUR4-120D1-EM NWUR4-120E1-EM NWUR4-277D1-EM NWUR4-UV1-EM	Air Tight ISUR4-120D1 ISUR4-120E1 ISUR4-277D1 ISUR4-UV1 Chicago Plenum and Polyurethane Air Tight ISUR4-120D1P ISUR4-120E1P ISUR4-277D1P ISUR4-UV1P
Performance 2 15W MAX	Non-IC and Air Tight REUR4-120D2 REUR4-120E2 REUR4-120EB2 REUR4-2772 REUR4-277D2 REUR4-UV2	Non-IC and Air Tight NWUR4-120D2 NWUR4-120E2 NWUR4-120EB2 NWUR4-2772 NWUR4-277D2 NWUR4-UV2 Emergency Driver Non-IC and Air Tight NWUR4-120D2-EM NWUR4-120E2-EM NWUR4-120EB2-EM NWUR4-2772-EM NWUR4-277D2-EM NWUR4-UV2-EM	Air Tight ISUR4-120D2 ISUR4-120E2 ISUR4-120EB2 ISUR4-2772 ISUR4-277D2 ISUR4-UV2 Chicago Plenum Air Tight ISUR4-120D2P ISUR4-120E2P ISUR4-120EB2P ISUR4-2772P ISUR4-277D2P ISUR4-UV2P

For dimming, please visit our Web site frequently to find our suggested compatible dimmers list:

www.contrastlighting.com

Contraste suggests ordering
**EB2 (ELV (+Value)/15W),
 D2 (0-10V/15W)**
 or
UV2 (ELV/0-10V/15W)
 dimming type and performance to use with Warm Dimming



COMPATIBLE HOUSINGS

	Remodel Housings	New Construction Housings	IC Housings
Performance 1 10W	IC and Air Tight REUR4-120D1	IC and Air Tight NWUR4-120D1	Air Tight ISUR4-120D1
Performance 2 15W	N/A	N/A	Air Tight ISUR4-120D2

CERTIFICATION

cULus **E343977** for damp locations
 Certified under California Energy Commission according to reference Appendix JA8

WARRANTY

1 year on components against manufacturing defects
 5 years on LED arrays and drivers

CONTRASTE

2018-01
 Revision 1

PRINTED IN CANADA

1009, rue du Parc Industriel
 Lévis (Québec) G6Z 1C5 Canada
 Tel.: 1-888-839-4624
 Fax.: 1-877-839-7057
contrastlighting.com
info@contrastlighting.com

© 2018 Contraste Lighting M.L. Inc.
 All rights reserved

Contrast Lighting M.L. Inc. reserves the right to make changes in specifications and/or to discontinue any product at any time without notice or obligation and will not be liable for any consequences resulting from the use of this publication.

SPECIFICATION SHEET

UR4A

4" Series Round Adjustable Trim



CODIFICATION EXAMPLE

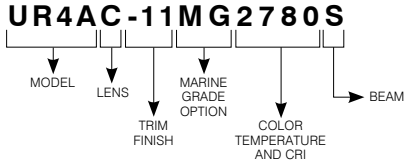

JA8 certified trim available without lens (std) and with 90+ CRI only.
Not available with Warm Dimming

ORDERING CODES

MODEL	LENSES	TRIM FINISHES	MARINE GRADE	COLOR TEMPERATURES AND CRI	BEAMS
UR4A					
UR4A	Without lens (std)	-01 White	MG (optional)	2780 2,700K (80+ CRI)	S Spot (16°)
C	Clear	-03SA Satin Gold	May be applied on finishes:	3080 3,000K (80+ CRI)	M Narrow Flood (32°)
F	Frosted	-04BR Brushed Chrome	-01, -11, -22 and -25	2790 2,700K (90+ CRI)	L Flood (48°)
H	Honeycomb	-11 Matte White		3090 3,000K (90+ CRI)	
L	Linear	-12BR Brushed Nickel		3590 3,500K (90+ CRI)	
P	Prismatic	-13 Satin Nickel		4090 4,000K (90+ CRI)	
S	Solite	-22 Matte Black		WD90 Warm Dimming (90+ CRI)	
		-25 Polar Grey			

Compatible with 15W drivers only (EB2, D2 and UV2)

GOOF RINGS

Goof rings will help you fix larger than necessary or damaged ceiling cutouts.

- Code:** **RR4-01** (White)
RR4-03SA (Satin Gold)
RR4-04BR (Brushed Chrome)
RR4-11 (Matte White)
RR4-12BR (Brushed Nickel)
RR4-13 (Satin Nickel)
RR4-22 (Matte Black)
RR4-25 (Polar Grey)

Outside diameter: ø 6-1/8" (156 mm)
 Inside diameter: ø 4-1/8" (105 mm)

MARINE GRADE

2-year warranty on finish
 This option increases the painted finishes resistance by reducing and delaying apparition and propagation of oxidation (ex: rust and others).
 MARINE GRADE treatment is recommended for damp to wet locations.
 Unless otherwise indicated, trims are for interior use. Also suitable for cold and exterior locations, as in soffits, where fixtures are not subject to direct rain or snow exposure.
WARNING – This option is not suitable for salt environments and/or highly corrosive areas such as soffits in coastal regions and natatoriums. Such usage would void warranty on the product.

UR4A

4" Series Round Adjustable Trim



PHOTOMETRIC DATA

In order to obtain the accurate photometric data, multiply the lumens relative to your product selection by the applicable factor(s) below tables. Take note these factors also need to be implemented in the .ies files available on our website.

With performance 1 housing

	Spot (16°)		Narrow Flood (32°)		Flood (48°)	
2,700K with 80+ CRI	806 lms	80.6 lms/W	994 lms	99.4 lms/W	994 lms	99.4 lms/W
3,000K with 80+ CRI	826 lms	82.6 lms/W	1,018 lms	101.8 lms/W	1,018 lms	101.8 lms/W

2,700K with 90+ CRI	670 lms	67 lms/W	826 lms	82.6 lms/W	826 lms	82.6 lms/W
3,000K with 90+ CRI	692 lms	69.2 lms/W	853 lms	85.3 lms/W	853 lms	85.3 lms/W
3,500K with 90+ CRI	731 lms	73.1 lms/W	901 lms	90.1 lms/W	901 lms	90.1 lms/W
4,000K with 90+ CRI	750 lms	75 lms/W	925 lms	92.5 lms/W	925 lms	92.5 lms/W
Warm Dimming with 90+ CRI	Not available with performance 1 housings					



Performance 1 Housings Factors

XXUR-120E1	0.90
XXUR-120D1 or XXUR-277D1	1

With performance 2 housing

	Spot (16°)		Narrow Flood (32°)		Flood (48°)	
2,700K with 80+ CRI	1,050 lms	70 lms/W	1,295 lms	86.3 lms/W	1,295 lms	86.3 lms/W
3,000K with 80+ CRI	1,075 lms	71.6 lms/W	1,326 lms	88.4 lms/W	1,326 lms	88.4 lms/W

2,700K with 90+ CRI	872 lms	58.1 lms/W	1,075 lms	71.6 lms/W	1,075 lms	71.6 lms/W
3,000K with 90+ CRI	901 lms	60 lms/W	1,111 lms	74 lms/W	1,111 lms	74 lms/W
3,500K with 90+ CRI	951 lms	63.4 lms/W	1,173 lms	78.2 lms/W	1,173 lms	78.2 lms/W
4,000K with 90+ CRI	977 lms	65.1 lms/W	1,205 lms	80.3 lms/W	1,205 lms	80.3 lms/W
Warm Dimming with 90+ CRI	527 lms	35.1 lms/W	650 lms	43.3 lms/W	650 lms	43.3 lms/W



Performance 2 Housings Factors

XXUR-120E2	0.95
XXUR-120EB2, XXUR-120D2, XXUR-2772 or XXUR-277D2	1

Lens Factors

STD	1
C	0.97
F	0.68
H	0.54

CONTRASTE

UR4A

4" Series Round Adjustable Trim



PHOTOMETRIC DATA

3,000K, 90+ CRI, Spot, Performance 1

CANDLEPOWER DISTRIBUTION

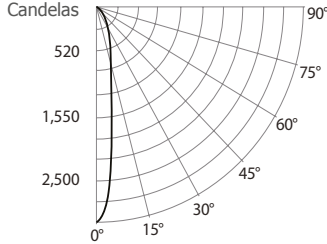

LIGHT CONE

Distance	FC	DIA
06'	85.6	1.7'
08'	48.1	2.3'
10'	30.8	2.9'
12'	21.4	3.5'
14'	15.7	4.1'
16'	12	4.7'

Beam: 16"
Beam Edge defined as 50% of Maximum Nadir Candle-power.

LUMINAIRE

Performance 1 LED	3,000K	Spot
CPCB / Lumens	3,080	/ 692
Watts	120V	277V
Operating AMPS	0.083A	0.036A
Lumen Maintenance	L70 @ 50,000 Hrs	
CRI	90+	
Lumens/Watt	69.2	
Spacing Criteria	0.07	

COEFFICIENT OF UTILIZATION - %

Ceiling Reflect %	80	50	30
Wall Reflect %	50	30	50
RCR	0	119	119
	111	111	106
	106	94	94
	96	96	84
	87	87	84
	81	81	76
	77	77	76
	70	70	70
	65	65	64

Zonal Cavity Method
Effective Floor Cavity Reflectance 20%

ZONAL LUMEN SUMMARY

ZONE	LUMENS	%LUMINAIRE
0-30	530.3	76.6%
0-40	639.5	92.4%
0-60	670.5	96.9%
60-90	21.5	3.1%
0-90	692.0	100%

MULTIPLE UNIT DATA - (RCR 2)

SPACING ON CENTER	INITIAL FOOTCANDLES	WATTS/ SQ. FT.
5'	34	0.44
6'	19	0.25
7'	13	0.17
8'	13	0.17
9'	8	0.11

38' x 38' x 10' Room. Workplan located 2-1/2' (30").
Reflectance factor 80%/50%/30%

CANDELAS DISTRIBUTION

DEGREES/ VERTICAL	CANDELAS
0	3,080
15	683
30	235
45	25
65	9
75	8
90	0

3,000K, 90+ CRI, Spot, Performance 2

CANDLEPOWER DISTRIBUTION

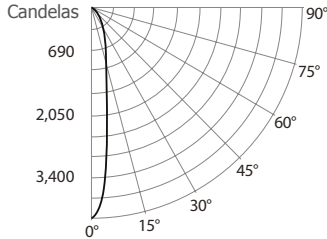

LIGHT CONE

Distance	FC	DIA
06'	111.4	1.7'
08'	62.7	2.3'
10'	40.1	2.8'
12'	27.8	3.4'
14'	20.5	4.0'
16'	15.7	4.5'

Beam: 16"
Beam Edge defined as 50% of Maximum Nadir Candle-power.

LUMINAIRE

Performance 2 LED	3,000K	Spot
CPCB / Lumens	4,010	/ 901.7
Watts	120V	277V
Operating AMPS	0.125A	0.054A
Lumen Maintenance	L70 @ 50,000 Hrs	
CRI	90+	
Lumens/Watt	60.1	
Spacing Criteria	0.07	

COEFFICIENT OF UTILIZATION - %

Ceiling Reflect %	80	50	30
Wall Reflect %	50	30	50
RCR	0	119	119
	111	111	106
	106	94	94
	96	96	84
	87	87	84
	81	81	76
	77	77	76
	70	70	69
	64	64	64

Zonal Cavity Method
Effective Floor Cavity Reflectance 20%

ZONAL LUMEN SUMMARY

ZONE	LUMENS	%LUMINAIRE
0-30	690.5	76.6%
0-40	832.5	92.3%
0-60	873.3	96.8%
60-90	28.4	3.2%
0-90	901.7	100%

MULTIPLE UNIT DATA - (RCR 2)

SPACING ON CENTER	INITIAL FOOTCANDLES	WATTS/ SQ. FT.
5'	44	0.66
6'	25	0.37
7'	17	0.26
8'	17	0.26
9'	11	0.17

38' x 38' x 10' Room. Workplan located 2-1/2' (30").
Reflectance factor 80%/50%/30%

CANDELAS DISTRIBUTION

DEGREES/ VERTICAL	CANDELAS
0	4 010
15	890
30	307
45	33
65	12
75	11
90	0

UR4A

4" Series Round Adjustable Trim



PHOTOMETRIC DATA

3,000K, 90+ CRI, Narrow Flood, Performance 1

CANDLEPOWER DISTRIBUTION

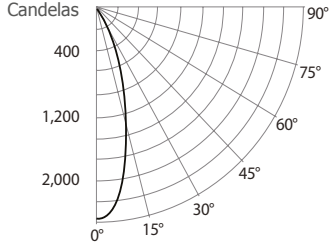

LIGHT CONE

Distance	FC	DIA
06'	65.3	3.5'
08'	36.7	4.7'
10'	23.5	5.9'
12'	16.3	7.1'
14'	12.0	8.3'
16'	9.2	9.5'

Beam: 33°
Beam Edge defined as 50% of Maximum Nadir Candle-power.

LUMINAIRE

Performance 1 LED	3,000K Narrow Flood	
CPCB / Lumens	2 350	/ 852,9
Watts	120V	277V
	10W	10W
Operating AMPS	0.083A	0.036A
Lumen Maintenance	L70 @ 50,000 Hrs	
CRI	90+	
Lumens/Watt	85.2	
Spacing Criteria	0.14	

COEFFICIENT OF UTILIZATION - %

Ceiling Reflect %	80		50		30	
Wall Reflect %	50	30	50	30	50	30
RCR 0	119	119	111	111	106	106
2	106	103	102	99	99	97
4	96	92	93	90	91	88
6	88	83	86	82	85	81
8	81	76	80	76	79	75
10	75	71	74	70	73	70

Zonal Cavity Method
Effective Floor Cavity Reflectance 20%

ZONAL LUMEN SUMMARY

ZONE	LUMENS	%LUMINAIRE
0-30	786.9	92.3%
0-40	846.2	99.2%
0-60	852.9	100%
60-90	0	0%
0-90	852.9	100%

MULTIPLE UNIT DATA - (RCR 2)

SPACING ON CENTER	INITIAL FOOTCANDLES	WATTS/SQ. FT.
5'	42	0.44
6'	24	0.25
7'	17	0.17
8'	17	0.17
9'	11	0.11

38' x 38' x 10' Room. Workplan located 2-1/2' (30").
Reflectance factor 80%/50%/30%

CANDELAS DISTRIBUTION

DEGREES/VERTICAL	CANDELAS
0	2,350
15	1,314
30	251
45	5
60	0
75	0
90	0

3,000K, 90+ CRI, Narrow Flood, Performance 2

DISTRIBUTION DES CANDELAS

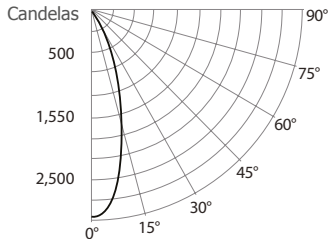

LIGHT CONE

Distance	FC	DIA
06'	85.0	3.5'
08'	47.8	4.7'
10'	30.6	5.9'
12'	21.3	7.1'
14'	15.6	8.3'
16'	12.0	9.5'

Beam: 33°
Beam Edge defined as 50% of Maximum Nadir Candle-power.

LUMINAIRE

Performance 2 LED	3,000K Narrow Flood	
CPCB / Lumens	3,061	/ 1,111.3
Watts	120V	277V
	15W	15W
Operating AMPS	0.125A	0.054A
Lumen Maintenance	L70 @ 50,000 Hrs	
CRI	90+	
Lumens/Watt	74	
Spacing Criteria	0.14	

COEFFICIENT OF UTILIZATION - %

Ceiling Reflect %	80		50		30	
Wall Reflect %	50	30	50	30	50	30
RCR 0	119	119	111	111	106	106
2	106	103	102	99	99	97
4	96	92	93	90	91	88
6	88	83	86	82	85	81
8	81	76	80	76	79	75
10	75	71	74	70	73	70

Zonal Cavity Method
Effective Floor Cavity Reflectance 20%

ZONAL LUMEN SUMMARY

ZONE	LUMENS	%LUMINAIRE
0-30	1,024.9	92.2%
0-40	1,102.2	99.2%
0-60	1,111.2	100%
60-90	0.1	0%
0-90	1,111.3	100%

MULTIPLE UNIT DATA - (RCR 2)

SPACING ON CENTER	INITIAL FOOTCANDLES	WATTS/SQ. FT.
5'	55	0.66
6'	31	0.37
7'	22	0.26
8'	22	0.26
9'	14	0.17

38' x 38' x 10' Room. Workplan located 2-1/2' (30").
Reflectance factor 80%/50%/30%

CANDELAS DISTRIBUTION

DEGREES/VERTICAL	CANDELAS
0	3,061
15	1,712
30	328
45	7
60	1
75	0
90	0

UR4A

4" Series Round Adjustable Trim



PHOTOMETRIC DATA

3,000K, 90+ CRI, Flood, Performance 1

CANDLEPOWER DISTRIBUTION

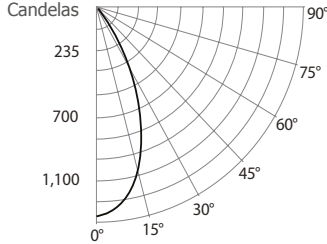

LIGHT CONE

Distance	FC	DIA
06'	37.6	5.4'
08'	21.1	7.2'
10'	13.5	9.0'
12'	9.4	10.8'
14'	6.9	12.6'
16'	5.3	14.4'

Beam: 48°
Beam Edge defined as 50% of Maximum Nadir Candle-power.

LUMINAIRE

Performance 1 LED	3,000K Flood	
CPCB / Lumens	1,353	/ 853.5
Watts	120V	277V
	10W	10W
Operating AMPS	0.083A	0.036A
Lumen Maintenance	L70 @ 50,000 Hrs	
CRI	90+	
Lumens/Watt	85.3	
Spacing Criteria	0.20	

COEFFICIENT OF UTILIZATION - %

Ceiling Reflect %	80			50			30		
Wall Reflect %	50	30	50	30	50	30	50	30	
RCR	0	119	119	111	111	106	106	106	
	2	105	101	100	97	97	94	94	
	4	93	88	89	85	87	84	84	
	6	83	77	81	76	79	75	75	
	8	75	69	73	68	72	68	68	
	10	68	62	66	62	66	61	61	

Zonal Cavity Method
Effective Floor Cavity Reflectance 20%

ZONAL LUMEN SUMMARY

ZONE	LUMENS	%LUMINAIRE
0-30	701.7	82.2%
0-40	822.3	96.3%
0-60	851.8	99.8%
60-90	1.6	0.2%
0-90	853.5	100%

MULTIPLE UNIT DATA - (RCR 2)

SPACING ON CENTER	INITIAL FOOTCANDLES	WATTS/SQ. FT.
5'	42	0.44
6'	23	0.25
7'	16	0.17
8'	16	0.17
9'	10	0.11

38' x 38' x 10' Room. Workplan located 2-1/2' (30").
Reflectance factor 80%/50%/30%

CANDELAS DISTRIBUTION

DEGREES/VERTICAL	CANDELAS
0	1,353
15	1,070
30	374
45	30
60	3
75	0
90	0

3,000K, 90+ CRI, Flood, Performance 2

CANDLEPOWER DISTRIBUTION

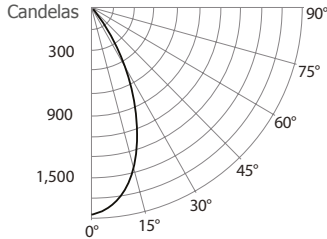

LIGHT CONE

Distance	FC	DIA
06'	48.9	5.4'
08'	27.5	7.2'
10'	17.6	9.0'
12'	12.2	10.8'
14'	9.0	12.6'
16'	6.9	14.4'

Beam: 48°
Beam Edge defined as 50% of Maximum Nadir Candle-power.

LUMINAIRE

Performance 2 LED	3,000K Flood	
CPCB / Lumens	1,762	/ 1,111.5
Watts	120V	277V
	15W	15W
Operating AMPS	0.125A	0.054A
Lumen Maintenance	L70 @ 50,000 Hrs	
CRI	90+	
Lumens/Watt	74.1	
Spacing Criteria	0.20	

COEFFICIENT OF UTILIZATION - %

Ceiling Reflect %	80			50			30		
Wall Reflect %	50	30	50	30	50	30	50	30	
RCR	0	119	119	111	111	106	106	106	
	2	105	101	100	97	97	94	94	
	4	93	88	89	85	87	84	84	
	6	83	77	81	76	79	75	75	
	8	75	69	73	68	72	68	68	
	10	68	62	66	62	66	61	61	

Zonal Cavity Method
Effective Floor Cavity Reflectance 20%

ZONAL LUMEN SUMMARY

ZONE	LUMENS	%LUMINAIRE
0-30	914.2	82.2%
0-40	1,071.3	96.4%
0-60	1,109.7	98.8%
60-90	1.8	0.2%
0-90	1,111.5	100%

MULTIPLE UNIT DATA - (RCR 2)

SPACING ON CENTER	INITIAL FOOTCANDLES	WATTS/SQ. FT.
5'	54	0.66
6'	30	0.37
7'	21	0.26
8'	21	0.26
9'	14	0.17

38' x 38' x 10' Room. Workplan located 2-1/2' (30").
Reflectance factor 80%/50%/30%

CANDELAS DISTRIBUTION

DEGREES/VERTICAL	CANDELAS
0	1,762
15	1,394
30	487
45	39
60	4
75	0
90	0