

# PRILUX

## 4" Series

Project	
Notes	
Fixture Type	
Date	

### Complete Unit: Non-IC New Construction Housing, Trim and LED lamp



PAR20 LED

#### DESCRIPTION

Non-IC New Construction housing can be installed in damp or wet (shower trim only) locations, indoor and outdoor.

#### HOUSING SPECIFICATIONS

HOUSING DETAILS	MAX 50W 0,030" (0,76 mm) thickness galvanized steel Below-ceiling accessible	
MOUNTING	Perfect fit into ceiling No light leakage	
CEILING FINISH	<b>Cutout</b> Ø 4-1/4" (108 mm)	<b>Thickness</b> Installs to ceilings up to 1-3/8" (35 mm) thick.
THERMAL PROTECTOR	TC 221°F (105°C)	
VOLTAGE	120 Volts	
CERTIFICATIONS	<ul style="list-style-type: none"> <li>cULus Listed <b>E252582</b> for damp or wet (shower trim only) locations</li> <li>Energy Star® certified lamp included</li> </ul>	

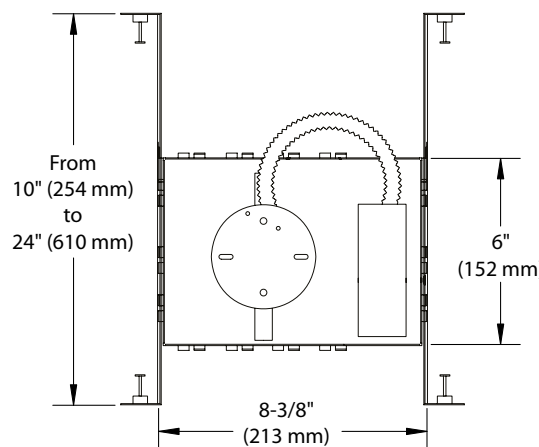
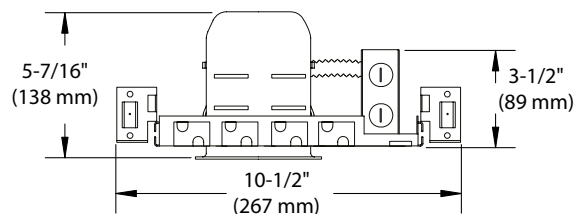

# PRILUX

## 4" Series

### TRIM SPECIFICATIONS

**LIGHT SOURCE**

**PAR16 LED High Brightness**

Color: Warm White (3,000K)  
 500 Lumen output  
 CRI: 90 +  
 Beam Angle: 40°  
 Lifespan: 50,000 hours  
 Power Consumption: 6.5W  
 Compatible with most incandescent, Magnetic Low Voltage (MLV) and Electronic Low Voltage (ELV) dimmers.

**PAR20 LED High Brightness**

Color: Warm White (3,000K)  
 600 Lumen output  
 CRI: 90 +  
 Beam Angle: 40°  
 Lifespan: 50,000 hours  
 Power Consumption: 7W  
 Compatible with most incandescent, Magnetic Low Voltage (MLV) and Electronic Low Voltage (ELV) dimmers.

**Due to constant evolution of LED lamps and associated dimmers we must test them regularly. We invite you to consult frequently our Web site to find our dimmer compatibility list: [www.contrastlighting.com](http://www.contrastlighting.com)**

**TRIM TYPES**

Round Adjustable Trim up to 20° for PAR16 LED and PAR20 LED in White **(-G01)**, Matte White **(-G11)** or Satin Nickel **(-G13)** and for PAR20 LED only Matte Black **(-G22)**

Round Adjustable Trim up to 20° for PAR16 LED White with Black Step Baffle **(-B01B)** and for PAR20 LED White with White Step Baffle **(-B01W)** or Black Step Baffle **(-B01B)**

Round Shower Trim for PAR16 LED and PAR20 LED in White **(-S01)** and for PAR20 LED only Matte White **(-S11)** and Satin Nickel **(-S13)**

**WARRANTY**

- Housing and Trims: 1 year
- PAR16 and PAR20 lamps, 50,000 hours (5 years)

**PAR16 Adjustable with Stepped Baffle**

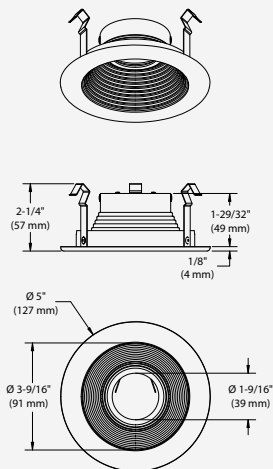

**PAR16 Adjustable**

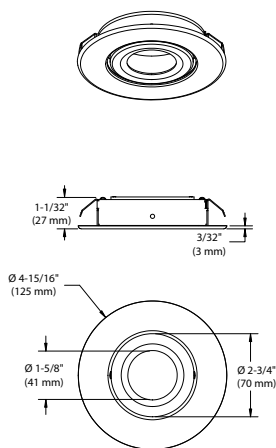

**PAR20 Adjustable with Step Baffle**

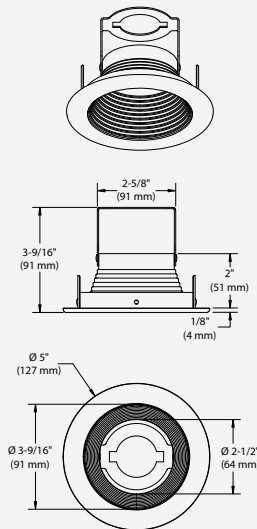

**PAR20 Adjustable**

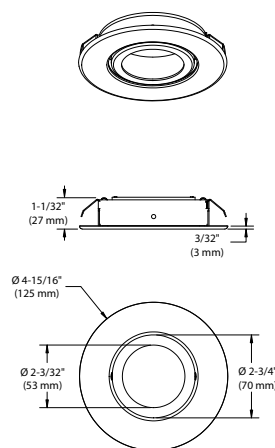

**PAR20 Shower**

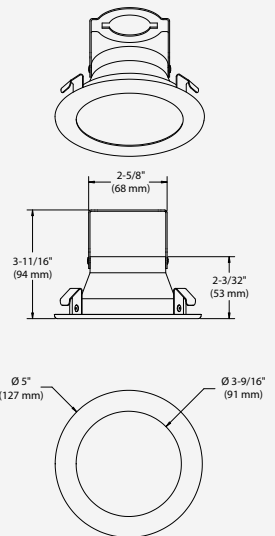

# PRILUX

## 4" Series

### CODIFICATION EXAMPLE

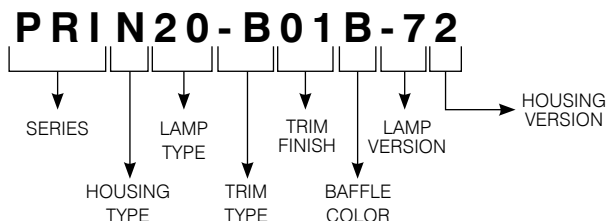

### ORDERING CODE for Complete Unit

SERIES	HOUSING TYPE	LAMP TYPE	TRIM TYPE	TRIM FINISH	BAFFLE COLOR	LAMP VERSION	HOUSING VERSION
<b>PRI</b>	<b>N</b>					<b>-7</b>	<b>2</b>
<b>PRI</b>	<b>N</b> New Construction	<b>16</b> PAR16	<b>-G</b> Adjustable	<b>01</b> White <b>11</b> Matte White <b>13</b> Satin Nickel	N/A	<b>-7</b> Generation 7	<b>2</b> Generation 2
		<b>16</b> PAR16	<b>-B</b> Adjustable with Step Baffle	<b>01</b> White	<b>B</b> Black		
		<b>16</b> PAR16	<b>-S</b> Shower	<b>01</b> White	N/A		
		<b>20</b> PAR20	<b>-G</b> Adjustable	<b>01</b> White <b>11</b> Matte White <b>13</b> Satin Nickel <b>22</b> Matte Black	N/A		
		<b>20</b> PAR20	<b>-B</b> Adjustable with Step Baffle	<b>01</b> White	<b>W</b> White <b>B</b> Black		
		<b>20</b> PAR20	<b>-S</b> Shower	<b>01</b> White <b>11</b> Matte White <b>13</b> Satin Nickel	N/A		

**Note:** For Contractor Pack (6 Complete Units), add **CPK** at the beginning of the ordering code.

**Ex.:** **CPKPRIN20-G01-72 (PAR20)**

**CPKPRIN16-G01-72 (PAR16)**



# CONTRASTE

1009, rue du Parc Industriel  
Lévis (Québec) G6Z 1C5 Canada  
Tel.: 1-888-839-4624 Fax: 1-877-839-7057  
info@contrastlighting.com  
www.contrastlighting.com

© 2016 Contrast Lighting M.L. Inc.  
All rights reserved

Contrast Lighting reserves the right to make changes in specifications and/or to discontinue any product at any time without notice or obligation and will not be liable for any consequences resulting from the use of this publication.