





**"NON-IC" TYPE HOUSING**  
**NW2575CA**

-  **yes**



---

- VOLTAGE 120 VOLTS**

---

-  \_\_\_\_\_
-  \_\_\_\_\_
-  **PAR30 75W max.**

---

-  \_\_\_\_\_
-  \_\_\_\_\_
-  **T°C 100°C No 027**

---

- Double top**

---

- UL number : E 174023**

---

- E Electronic M Magnetic C Short L Long**

 **OD Cut : 4 5/8" (117 mm)**

NOTES:  
 For ceiling without insulation  
 Below ceiling access

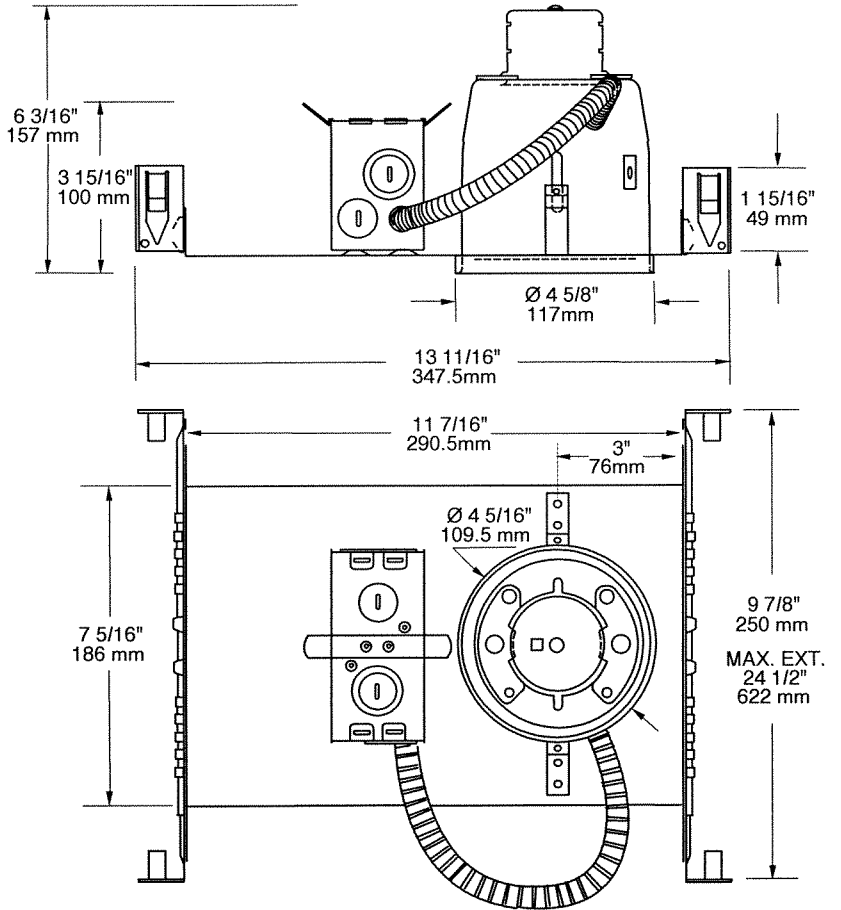

**PROJECT**

Your Project: \_\_\_\_\_  
 \_\_\_\_\_  
 \_\_\_\_\_

Representative: \_\_\_\_\_