

NW2550CAU

3-1/2" PAR20 Series

New Construction Housing for PAR20 Lamp

| | |
|--------------|--|
| Project | |
| Notes | |
| Fixture Type | |
| Date | |

SPECIFICATIONS

HOUSING DETAILS 18 gauge 0,051" (1,3 mm) thickness galvanized steel.
 Junction box can support up to 10 – 14 gauge wires or 8 – 12 gauge wires.
 Below-ceiling accessible.

SOCKET Porcelain; medium base socket (E26).
 Pre-wired with 18 gauge wire SEW 200°C connected to the junction box.

MOUNTING **Cutout diameter: Ø 3-3/4" (95 mm)**
 Can fit in ceilings up to 7/8" (22 mm) thick.
 Requires a 4-1/2" (114 mm) clearance beyond the ceiling material.
 Contraste hooks for ease of installation and a perfect fit to ceiling.
 Mounting bars extend from 10" (254 mm) to 24-1/2" (622 mm) to fit in most ceiling structures (compatible with suspended ceilings).
 No light leakage.

LIGHT SOURCE **PAR20 Halogen Lamp 50W MAX**
 This product was designed for a PAR20 halogen lamp. If you want to use dimming and you replace PAR20 lamp by an equivalent LED PAR20 lamp, please refer regularly to the lamp manufacturer dimmer compatibility list.

COMPATIBLE TRIMS AND ACCESSORIES C2550 Collar (all standard finishes are available)



BAFRE2550 Baffle (-01 White / -02 Black)

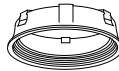

REFFRE2550 Reflector (-BK Black / -CL Clear)

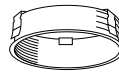

*The C2550 collar requires either a BAFRE2550 baffle or REFRE2550 reflector for fixed.

VOLTAGE 120 Volts (CAN & USA)

THERMAL PROTECTION TC 212°F (100°C)

CERTIFICATION cULus **E174023** for damp locations

WARRANTY 5 years on socket.

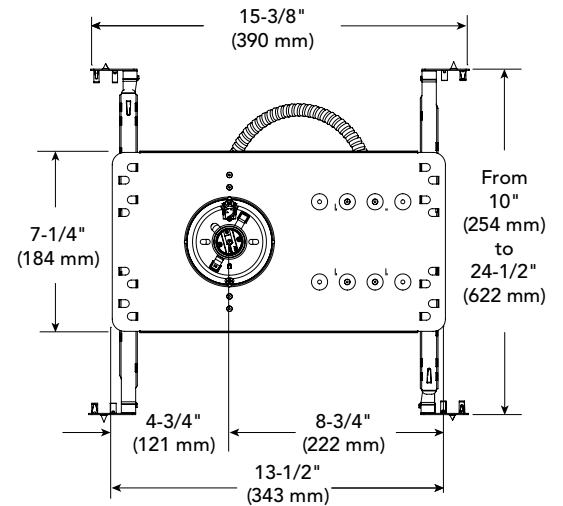
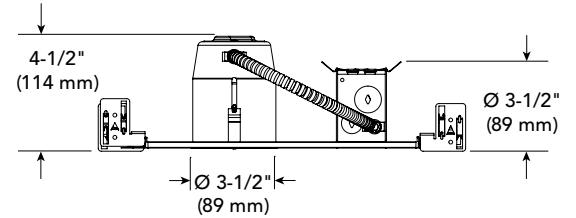
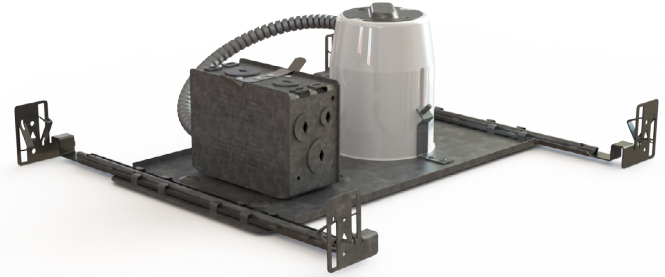

CONTRASTE

1009, rue du Parc Industriel
 Lévis (Québec) G6Z 1C5 Canada
 Tel.: 1-888-839-4624
 Fax.: 1-877-839-7057
 contrastlighting.com
 info@contrastlighting.com

© 2016 Contrast Lighting M.L. Inc.
 All rights reserved

Contrast Lighting M.L. Inc reserves the right to make changes in specifications and/or to discontinue any product at any time without notice or obligation and will not be liable for any consequences resulting from the use of this publication.

NW2550CAU

3-1/2" PAR20 Series

HOUSING CODIFICATION EXAMPLE

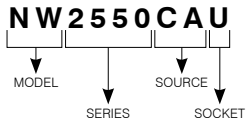

ORDERING CODE

| MODEL | SERIES | SOURCE | SOCKET |
|------------------------------------|---------------------------------|----------------------|--------------------|
| NW | 2550 | CA | U |
| NW New Construction Housing | 2550 3-1/2" PAR20 Series | CA PAR20 Lamp | U Universal |

BAFFLE CODIFICATION EXAMPLE

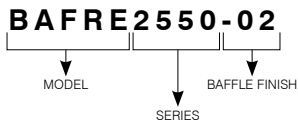

ORDERING CODE

| MODEL | SERIES | BAFFLE FINISHES |
|------------------------|---------------------------------|--------------------------------------|
| BAFRE | 2550 | |
| BAFRE Deflector | 2550 3-1/2" PAR20 Series | -01 White -02 Black |

REFLECTOR CODIFICATION EXAMPLE

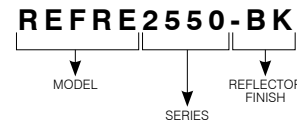

ORDERING CODE

| MODEL | SERIES | REFLECTOR FINISHES |
|------------------------|---------------------------------|--------------------------------------------------------|
| REFRE | 2550 | |
| REFRE Reflector | 2550 3-1/2" PAR20 Series | -BK Anodized Black -CL Anodized Clear |

COLLAR CODIFICATION EXAMPLE

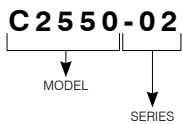

ORDERING CODE

| MODEL | COLLAR FINISHES | MARINE GRADE |
|--------------|-----------------------------------------------------------------------------------------------------------------------------------------------------------|-------------------------------------------------------------------------------------------------------------------------------------------|
| C2550 | | |
| C2550 | -01 White -02 Black -03 Gold Plated 24K -04 Chrome -04BR Brushed Chrome -05 Architectural Bronze | -06 Antique Copper -11 Matte White -12BR Brushed Nickel -13 Satin Nickel -15 Metallic Grey |
| | | MG (optional) May be applied on finishes: -01, -02, -05, -06, -11 and -15 |



CONTRASTE

1009, rue du Parc Industriel
Lévis (Québec) G6Z 1C5 Canada
Tel.: 1-888-839-4624
Fax.: 1-877-839-7057
contrastlighting.com
info@contrastlighting.com

© 2016 Contrast Lighting M.L. Inc.
All rights reserved

Contrast Lighting M.L. Inc reserves the right to make changes in specifications and/or to discontinue any product at any time without notice or obligation and will not be liable for any consequences resulting from the use of this publication.