

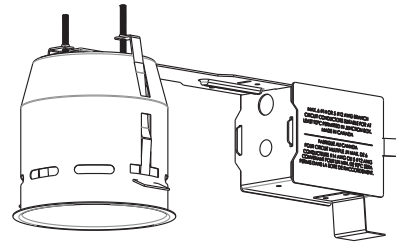







SPECIFICATION SHEET

4 1/4" 7000 SERIES

IT7000E IT7000E2

REMODEL HOUSING WITH ELECTRONIC CONVERTER



	YES
Damp Location	
	MR16 50W MAX
MR16	
	120 VOLTS (CAN & USA.) 277 VOLTS (USA ONLY)
Voltage	
	Electronic Converter IT7000E : 120V / 12V IT7000E2 : 277V / 12V
	T°C 120°C No 031
Thermal Protector	
	4 5/16" (109mm)
OD Cut	
	E174023
UL LISTED	
	Overall Dimensions : Length : 13 5/16" (338mm) Width : 5" (127mm) Height : 6" (152mm)
Dimensions	

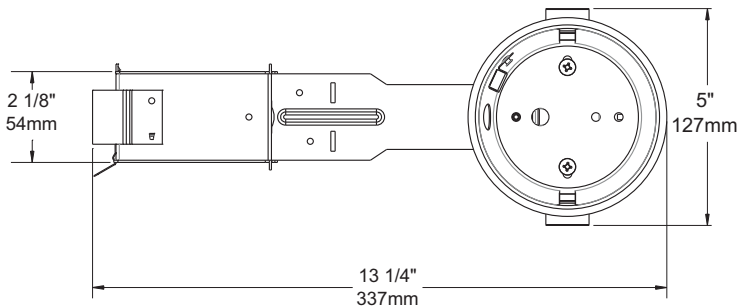
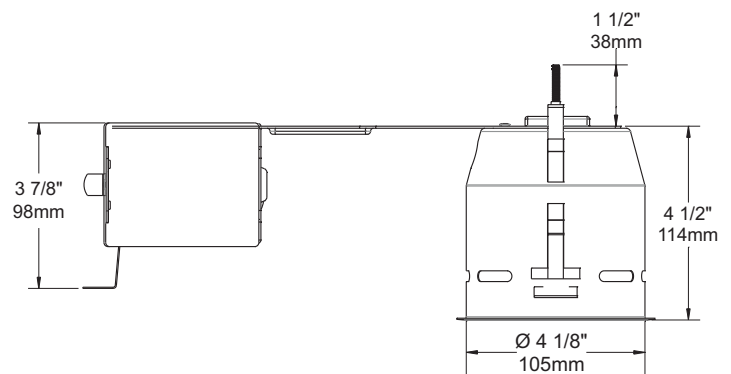

COMPATIBLE TRIMS

50W MR16

T7024
T7025
T7800

TECHNICAL SPECIFICATIONS

0,051" (1,3mm) thickness Galvanized Steel.
Below-ceiling accessible.
Hooks PAT#CAN 2,088,648 and #USA 5,377,088.
Takes up to 7/8" thick ceiling.
Perfect fit into ceiling.
No light leak.
Each part of the case should be at 3 "(76mm) MINIMUM from insulation (if applicable).



Your representative : _____

Your project : _____