

SPECIFICATION SHEET

Ardito LED - A4RWW

4" Series

Ultra-Thin Profile Round Wall Wash Trim

Project _____

Notes _____

Fixture Type _____

Date _____



WITH FLANGE

A4RWW-2222 - XXX (illustrated)



FLANGELESS TRIM

A2RWW-TR22 - XXX (illustrated)

Round, 4" high efficiency wall wash dimmable LED. May be installed with a low profile ultra-thin flange or flangeless trim in configuration for insulated, non-insulated and remodel (non-IC) ceilings.



SPECIFICATIONS

COLOR TEMPERATURES 2,700K - 3,000K - 3,500K - 4,000K

CRI 90+

POWER SUPPLY 120V - 277V
 One driver model available in two performances (14W and 23W) and offering 2 dimming options:
 ELV: 120V (14W and 23W) (120V only)
 0-10V: 120V (14W and 23W) (120V only)
 Consult housing specification sheet for more details

Requires a 6-1/2" (165 mm) clearance beyond the ceiling level for standard using and 7" (178 mm) for Lumenetix option using.
 0.036" (0.91 mm) galvanized steel housing

HOUSING DETAILS Perfect fit into ceiling

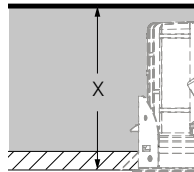

Each part of the housing should be at LEAST 3" (76 mm) from insulation (non-IC configurations)
 Can fit in ceilings up to 1-1/2" (38 mm) thick
 Junction box is accessible from below the ceiling for ease of maintenance

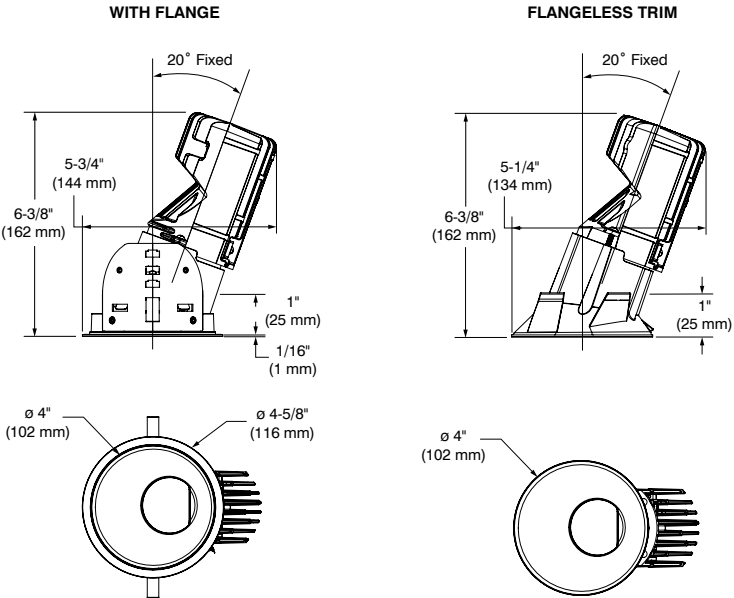

CONTRASTE

Ardito LED - A4RWW

4" Series

Ultra-Thin Profile Round Wall Wash Trim



SPECIFICATIONS (CONT'D)

	Remodel Housing	New Construction Housing	Insulated Housing	Ceiling thickness suggested for insulated housing as a using standard and Lumenetix option.
COMPATIBLE HOUSINGS	Performance 1	REA4V1	NWA4RV1	* ISA4RV1
	Performance 2	REA4V2	NWA4RV2	* ISA4RV2
	Lumenetix	REA4VL	NWA4RVL	** ISA4RVL

* Ceiling thickness must be at least 1/2" (13 mm) for insulated housing as a using standard.

** Ceiling thickness must be at least 1" (25 mm) for insulated housing with Lumenetix option.

For dimming, please visit our Web site frequently to find our dimmer compatibility list: www.contrastlighting.com

MUD-IN-PLATE

MIPA4R (sold separately)
Consult housing specification sheet for more details.

DELIVERED LUMENS

Performance 1 (14W) Standard: 442.8 lumens @ 3,000K, 32.5 lm/W
Performance 2 (23W) Standard: 629.3 lumens @ 3,000K, 46 lm/W
Lumenetix (12,5W): up to 700 lumens

LIGHT ENGINE

Standard:

Lumileds Luxeon CoB 1205 GEN2 and CoB 1203 GEN2 (Spot Beam Only) deliver a lumen maintenance greater than 70% after 50,000 hours of operation (L_{70}). Provide a high quality true color and a clean white light without hot spots. Color binning within 3 steps on MacAdam ellipse which surpasses ANSI binning requirements.

Lumenetix Warm Dimming:

Lumenetix Araya DDM1 Dynamic Dimming Module delivers dimmable white light that warms as it dims, reproducing dimming conditions of a halogen lamp. It allows the user to change the color temperature from 3,050K at full intensity to 1,800K at minimum intensity all this while ensuring a 90+ CRI over the full dimming range.
Lumenetix: 120V - 277V (12.5W)

Lumenetix Color Tuning:

Lumenetix Araya CTM1 Color Tuning Module allows the user to program millions of color combinations using a user-friendly Bluetooth application available on iOS mobile devices. The application allows programming of different scenes, colors, and color temperatures while the day-to-day control is ensured by standard 0-10V wall mounted dimmers. 90+ CRI.
Lumenetix: 120V - 277V (12.5W)

TRIM FINISHES

Powder coated paint or plated die formed steel.
Different finishes available: 24K Gold Plated **(-03)**, Chrome **(-04)**, Brushed Chrome **(-04BR)**, Matte White **(-11)**, Brushed Nickel **(-12BR)**, Satin Nickel **(-13)**, Antique Nickel **(-17)**, Matte Black **(-22)**

FLANGELESS TRIM

Steel mud-in-plate for flangeless trim, allows you to apply plaster up to Ardito fixture opening edges.
For this option, please refer to ordering code.

CONTRASTE

SPECIFICATION SHEET

Ardito LED - A4RWW

4" Series

Ultra-Thin Profile Round Wall Wash Trim

SPECIFICATIONS (CONT'D)

REFLECTOR FINISHES	Painted	Anodized (AN)	* Recommended for optimum Wall Wash result
	Matte White (11) * Matte Black (22)		

OPTIC SYSTEM	Choice of available lenses: Standard - Frosted / Frosted (included)
	Lens (for replacement): Standard - Frosted / Frosted (refer to page 7 for more details)
	* Consult .ies files on our Website for more details.

HEAT SINK	High quality aluminum injected heat sink ensuring maximum heat dissipation.
-----------	---

THERMAL PROTECTION	Performance 1: TC 212°F (100°C)
	Performance 2: TC 212°F (100°C)
	Lumenetix: TC 194°F (90°C)

CEILING CUTOUT	ø 4-1/4" (108 mm)
----------------	--------------------------

CERTIFICATION	• cULus E343977 for damp locations
	• Certified Air Tight ASTM E283

WARRANTY	1 year on components against manufacturing defects
	5 years on LED arrays and drivers

CONTRASTE

Ardito LED - A4RWW

4" Series

Ultra-Thin Profile Round Wall Wash Trim

PHOTOMETRIC DATA



3,000K, 90+ CRI, Flood, Performance 1

CANDLEPOWER DISTRIBUTION

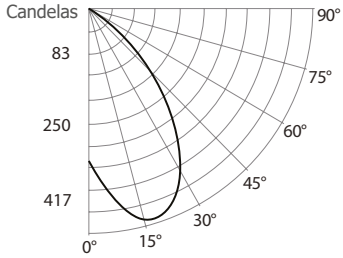

LIGHT CONE

Distance	FC	DIA
04'	21.5	4.0'
08'	5.4	8.1'
12'	2.4	12.1'
16'	1.3	16.2'

Beam: 54°
Beam Edge defined as 50% of Maximum Nadir Candle-power.

LUMINAIRE

Performance 1 LED	3,000K Flood	
CBCP / Lumens	494	/ 442.8
Watts	120V	277V
	13.2W	13.7W
Operating AMPS	0.11A	0.05A
Lumen Maintenance	L70 @ 50,000 Hrs	
CRI	90+	
Lumens/Watt	32.5	
Spacing Criteria	0.95	

COEFFICIENT OF UTILIZATION - %

Ceiling Reflect %	80		50		30		
Wall Reflect %	50	30	50	30	50	30	
RCR	0	112	112	105	105	100	100
	2	94	90	89	86	86	84
	4	79	73	76	71	74	70
	6	67	61	65	59	63	59
	8	58	51	56	51	55	50
	10	50	44	49	44	48	43

Zonal Cavity Method
Effective Floor Cavity Reflectance 20%

ZONAL LUMEN SUMMARY

ZONE	LUMENS	%LUMINAIRE
0-30	230.1	52%
0-40	333.2	75.2%
0-60	434.8	98.2%
60-90	8.0	1.8%
0-180	442.8	100%

CANDELAS DISTRIBUTION

DEGREES/ VERTICAL	CANDELAS	DEGREES/ VERTICAL	CANDELAS
0	343	40	278
5	404	50	125
10	458	60	46
15	487	70	3
20	486	80	0
25	461	90	0
30	413		

Footcandles On Wall - Performance 1

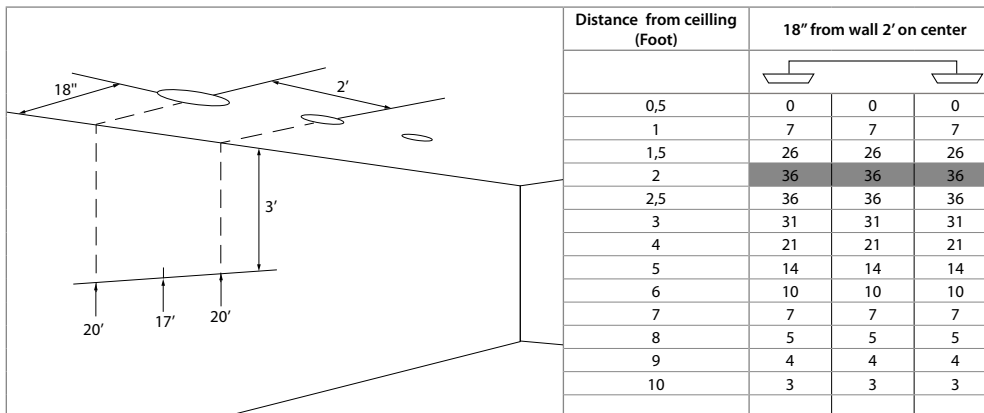

Note: Footcandles Data

CONTRASTE

Ardito LED - A4RWW

4" Series

Ultra-Thin Profile Round Wall Wash Trim

PHOTOMETRIC DATA



3,000K, 90+ CRI, Flood, Performance 2

CANDLEPOWER DISTRIBUTION

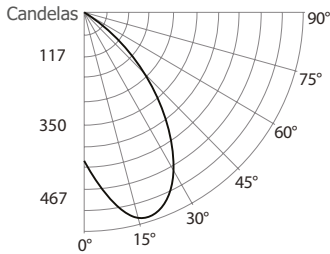

LIGHT CONE

Distance	FC	DIA
06'	29.4	4.1'
08'	7.4	8.2'
10'	3.3	12.3'
12'	1.2	16.3'

Beam: 54°
Beam Edge defined as 50% of Maximum Nadir Candle-power.

LUMINAIRE

Performance 2 LED	3,000K Flood	
CBCP / Lumens	691	629.3
Watts	120W	277V
	13.63W	13.97W
Operating AMPS	0.11A	0.05A
Lumen Maintenance	L70 @ 50,000 Hrs	
CRI	90+	
Lumens/Watt	46.17	
Spacing Criteria	0.95	

COEFFICIENT OF UTILIZATION - %

Ceiling Reflect %	80		50		30		
Wall Reflect %	50	30	50	30	50	30	
RCR	0	112	112	104	104	100	100
	2	94	89	89	86	86	83
	4	79	72	75	70	73	69
	6	67	60	64	59	63	58
	8	57	51	55	50	54	49
	10	50	44	49	43	48	43

Zonal Cavity Method
Effective Floor Cavity Reflectance 20%

ZONAL LUMEN SUMMARY

ZONE	LUMENS	%LUMINAIRE
0-30	319.9	50.8%
0-40	468	74.3%
0-60	618.1	98.1%
60-90	11.8	1.9%
0-90	629.9	100%

CANDELAS DISTRIBUTION

DEGREES/ VERTICAL	CANDELAS	DEGREES/ VERTICAL	CANDELAS
0	471	40	398
5	555	50	188
10	633	60	68
15	679	70	3
20	683	80	0
25	651	90	0
30	584		

Footcandles On Wall - Performance 2

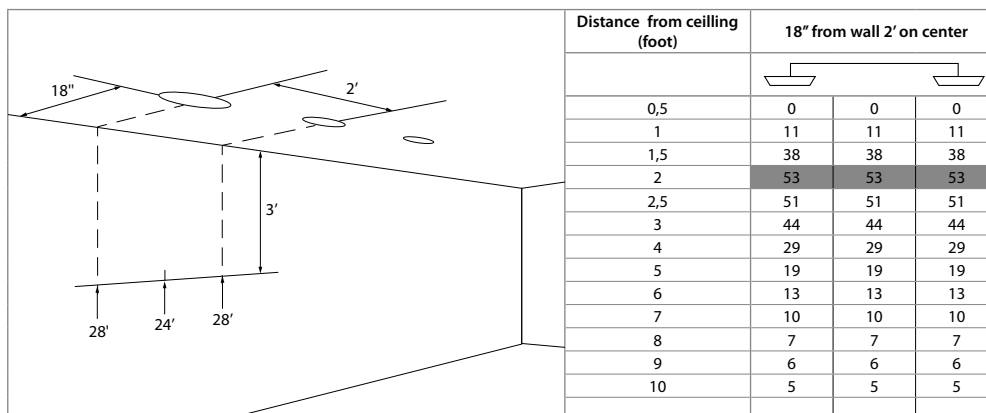

Note: Footcandles Data

Ardito LED - A4RWW

4" Series

Ultra-Thin Profile Round Wall Wash Trim

TRIM WITH FLANGE CODIFICATION EXAMPLE

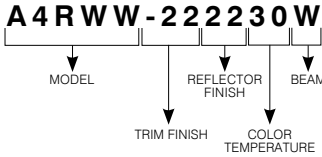

TRIM WITH FLANGE ORDERING CODE **A4RWW**

MODEL	TRIM FINISHES	REFLECTOR FINISHES	COLOR TEMPERATURES	BEAM
A4RWW				W
A4RWW	-03 24K Gold Plated	Painted	27 2,700K	W Flood (54°)
	-04 Chrome	11 Matte White	30 3,000K	
	-04BR Brushed Chrome	22 *Matte Black	35 3,500K	
	-11 Matte White	AN Anodized	40 4,000K	
	-12BR Brushed Nickel		CT Color Tuning	
	-13 Satin Nickel	* Recommended for optimum Wall Wash result	WD Warm Dimming	
	-17 Antique Nickel			
	-22 Matte Black			

FLANGELESS TRIM OPTION CODIFICATION EXAMPLE

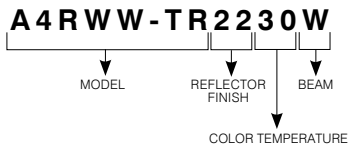

FLANGELESS TRIM OPTION ORDERING CODE **A4RWW-TR** (see next page for mud-in-plate ordering code)

MODEL	REFLECTOR FINISHES	COLOR TEMPERATURES	BEAM
A4RWW-TR			W
A4RWW-TR	Painted	27 2,700K	W Flood (54°)
	11 Matte White	30 3,000K	
	22 * Matte Black	35 3,500K	
	AN Anodized	40 4,000K	
		CT Color Tuning	
	* Recommended for optimum Wall Wash result	WD Warm Dimming	

Ardito LED - A4RWW

4" Series

Ultra-Thin Profile Round Wall Wash Trim



ORDERING CODE for lenses replacement

Frosted / Frosted: **317285** (included)

ORDERING CODE for Mud-in-Plate

MIPA4R

Consult housing specification sheet for more details.

CONTRASTE