

SPECIFICATION SHEET

Ardito LED - A2RFR

2-1/2" Series

Ultra-Thin Profile Round Regressed Trim

Project _____

Notes _____

Fixture Type _____

Date _____

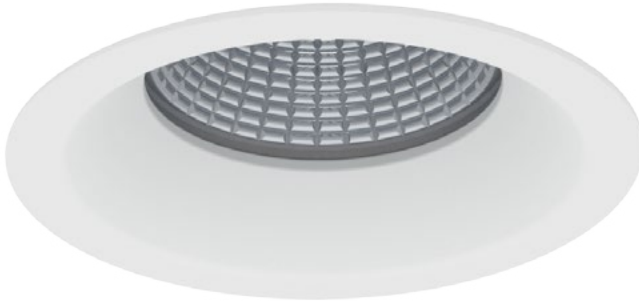

WITH FLANGE

A2RFR-11XXX (illustrated)

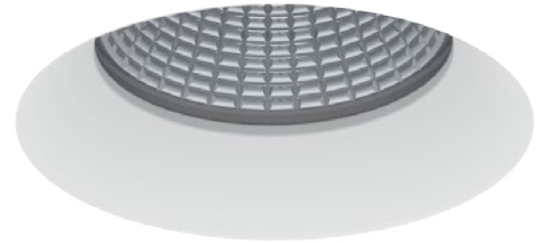

FLANGELESS TRIM

A2RFR-TRXXX (illustrated)

Ultra-Thin Profile Downlight Round Regressed Trim, 2-1/2" high efficiency dimmable LED. Offered in Remodel configuration (NON-IC) or with optional mounting plate for a new construction configuration (NON-IC).

SPECIFICATIONS

COLOR TEMPERATURE 2,700K - 3,000K - 3,500K - 4,000K

CRI 90+

POWER SUPPLY 120V - 277V
 One driver available in performance 1 (14W) and offers 2 dimming options:
 ELV: 120V (14W) (120v only)
 0-10V: 120V (14W) (120v only)
 Consult housing specification sheet for more details.

Requires a 5" (127 mm) clearance beyond the ceiling level.

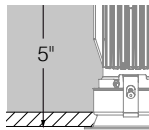

HOUSING DETAILS Each part of the housing should be at LEAST 3" (78 mm) from insulation. Can fit in 1/2" (12 mm) to 1-3/8" (35 mm) thick ceiling. Junction Box is accessible from below the ceiling for ease of maintenance.

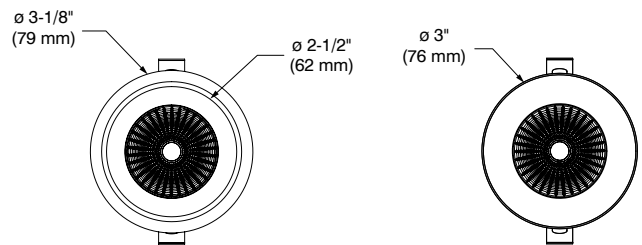
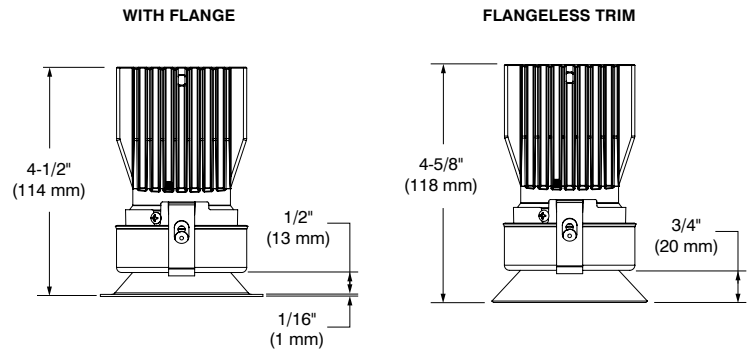

Remodel Housing

Performance 1	REA2V1
----------------------	--------

COMPATIBLE HOUSING

For dimming, please visit our Web site frequently to find our dimmer compatibility list:
www.contrastlighting.com

CONTRASTE

1009, rue du Parc Industriel
 Lévis (Québec) G6Z 1C5 Canada
 Tel.: 1-888-839-4624
 Fax.: 1-877-839-7057
 contrastlighting.com
 info@contrastlighting.com

© 2017 Contrast Lighting M.L. Inc.
 All rights reserved

Contrast Lighting M.L. Inc. reserves the right to make changes in specifications and/or to discontinue any product at any time without notice or obligation and will not be liable for any consequences resulting from the use of this publication.

SPECIFICATION SHEET

Ardito LED - A2RFR

2-1/2" Series

Ultra-Thin Profile Round Regressed Trim

SPECIFICATIONS (CONT'D)

MUD-IN-PLATE	MIPA2R (sold separately) Consult housing specification sheet for more details.						
DELIVERED LUMENS	Performance 1 (14W): 1,037 lumens @ 3,000K, 78.5 lm/W						
LED ARRAY	Standard: Lumileds Luxeon CoB 1203 GEN2 delivers a lumen maintenance greater than 70% after 50,000 hours of operation (L ₇₀) and provides a high quality true color and a clean white light without hot spots. Color binning within 3 steps on MacAdam ellipse which surpasses ANSI binning requirements.						
TRIM FINISHES	Powder coated paint or plated die formed steel. Different finishes available: 24K Gold Plated (-03) , Chrome (04) , Brushed Chrome (-04BR) , Matte White (-11) , Brushed Nickel (-12BR) , Satin Nickel (-13) , Antique Nickel (-17) , Matte Black (-22)						
OPTIC SYSTEM	Interchangeable optional optical reflectors and lenses available to customize your lighting. Choice of available lenses: Clear (C) (included) Accessories (sold separately): Frosted (F) , Honeycombs (H) , Linear (L) , Prismatic (P) and Solite (S) (Color lenses available upon request) Optical reflectors available: <table border="1" style="margin-left: auto; margin-right: auto;"> <thead> <tr> <th colspan="2" style="text-align: center;">Beams</th> </tr> </thead> <tbody> <tr> <td>Narrow Flood (M)</td> <td style="text-align: center;">25°</td> </tr> <tr> <td>Flood (W)</td> <td style="text-align: center;">44°</td> </tr> </tbody> </table> * Average beams shown. Consult .ies files on our Web site for more details.	Beams		Narrow Flood (M)	25°	Flood (W)	44°
Beams							
Narrow Flood (M)	25°						
Flood (W)	44°						
HEAT SINK	High quality aluminum injected heat sink ensuring maximum heat dissipation						
THERMAL PROTECTION	Performance 1: TC 194°F (90°C)						
CEILING CUTOUT	ø 2-5/8" (67 mm) ø 3-3/16" (81 mm) (Flangeless Trim option)						
CERTIFICATION	<ul style="list-style-type: none"> cULus E343977 for damp locations Certified Air Tight ASTM E283 						
WARRANTY	1 year on components against manufacturing defects 5 years on LED arrays and drivers						

CONTRASTE

1009, rue du Parc Industriel
Lévis (Québec) G6Z 1C5 Canada
Tel.: 1-888-839-4624
Fax.: 1-877-839-7057
contrastlighting.com
info@contrastlighting.com

© 2017 Contrast Lighting M.L. Inc.
All rights reserved

Contrast Lighting M.L. Inc. reserves the right to make changes in specifications and/or to discontinue any product at any time without notice or obligation and will not be liable for any consequences resulting from the use of this publication.

Ardito LED - A2RFR

2-1/2" Series

Ultra-Thin Profile Round Regressed Trim

PHOTOMETRIC DATA



3,000K, 90+ CRI, Narrow Flood, performance 1

CANDLEPOWER DISTRIBUTION

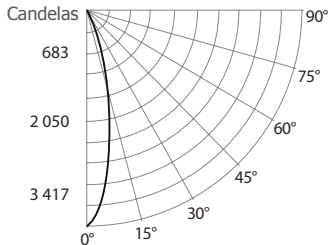

LIGHT CONE

Distance	FC	DIA
06'	113	2.5
08'	63.6	3.4
10'	40.7	4.2
12'	28.3	5.1
14'	20.8	5.9
16'	15.9	6.7

Beam: 24°
Beam Edge defined as 50% of Maximum Nadir Candle-power.

LUMINAIRE

Performance 1 LED	3,000K	Narrow Flood
CBCP / Lumens	4,068 /	1,037
Watts	120V	277V
	13.2W	13.7W
Operating AMPS	0.11A	0.049A
Lumen Maintenance	L70 @ 50,000 Hrs	
CRI	90+	
Lumens/Watt	78.5	
Spacing Criteria	0.77	

COEFFICIENT OF UTILIZATION - %

Ceiling Reflect %	80		50		30		
Wall Reflect %	50	30	50	30	50	30	
RCR	0	119	119	111	111	106	106
	2	107	104	102	100	99	98
	4	98	94	95	91	93	90
	6	90	86	88	84	87	84
	8	84	79	82	79	81	78
	10	78	74	77	74	77	73

Zonal Cavity Method
Effective Floor Cavity Reflectance 20%

ZONAL LUMEN SUMMARY

ZONE	LUMENS	%LUMINAIRE
0-30	976.3	94.1%
0-40	1,036.4	99.9%
0-60	1,036.9	100%
60-90	0.0	0%
0-180	1,037	100%

MULTIPLE UNIT DATA - (RCR 2)

SPACING ON CENTER	INITIAL FOOTCANDLES	WATTS/SQ. FT.
5'	49	0.59
6'	28	0.33
7'	19	0.23
8'	19	0.23
9'	12	0.15

38' x 38' x 10' Room. Workplan located 2-1/2' (30").
Reflectance factor 80%/50%/30%

CANDELAS DISTRIBUTION

DEGREES/VERTICAL	CANDELAS	DEGREES/VERTICAL	CANDELAS
0	4,068	40	1
5	3,507	50	0
10	2,422	60	0
15	1,397	70	0
20	783	80	0
25	494	90	0
30	255		

3,000K, 90+ CRI, Flood, performance 1

CANDLEPOWER DISTRIBUTION

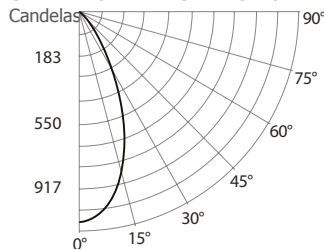

LIGHT CONE

Distance	FC	DIA
06'	50.9	5.0
08'	28.6	6.7
10'	18.3	8.3
12'	12.7	10.0
14'	9.3	11.7
16'	7.2	13.4

Beam: 45°
Beam Edge defined as 50% of Maximum Nadir Candle-power.

LUMINAIRE

Performance 1 LED	3,000K	Flood
CBCP / Lumens	1,832 /	976
Watts	120V	277V
	14.2W	14.7W
Operating AMPS	0.12A	0.053A
Lumen Maintenance	L70 @ 50,000 Hrs	
CRI	90+	
Lumens/Watt	68.7	
Spacing Criteria	0.99	

COEFFICIENT OF UTILIZATION - %

Ceiling Reflect %	80		50		30		
Wall Reflect %	50	30	50	30	50	30	
RCR	0	119	119	111	111	106	106
	2	106	102	101	98	98	96
	4	95	90	92	88	90	87
	6	86	81	84	80	82	79
	8	78	73	77	72	76	72
	10	72	67	71	66	70	66

Zonal Cavity Method
Effective Floor Cavity Reflectance 20%

ZONAL LUMEN SUMMARY

ZONE	LUMENS	%LUMINAIRE
0-30	889.2	91.1%
0-40	972.2	99.9%
0-60	975.6	100%
60-90	0.4	0%
0-90	976	100%

MULTIPLE UNIT DATA - (RCR 2)

SPACING ON CENTER	INITIAL FOOTCANDLES	WATTS/SQ. FT.
5'	46	0.63
6'	26	0.35
7'	18	0.25
8'	18	0.25
9'	11	0.16

38' x 38' x 10' Room. Workplan located 2-1/2' (30").
Reflectance factor 80%/50%/30%

CANDELAS DISTRIBUTION

DEGREES/VERTICAL	CANDELAS	DEGREES/VERTICAL	CANDELAS
0	1,832	40	14
5	1,793	50	1
10	1,666	60	0
15	1,440	70	0
20	1,119	80	0
25	737	90	0
30	370		

CONTRASTE

1009, rue du Parc Industriel
Lévis (Québec) G6Z 1C5 Canada
Tel.: 1-888-839-4624
Fax.: 1-877-839-7057
contrastlighting.com
info@contrastlighting.com

© 2017 Contrast Lighting M.L. Inc.
All rights reserved

Contrast Lighting M.L. Inc. reserves the right to make changes in specifications and/or to discontinue any product at any time without notice or obligation and will not be liable for any consequences resulting from the use of this publication.

Ardito LED - A2RFR

2-1/2" Series

Ultra-Thin Profile Round Regressed Trim



TRIM WITH FLANGE CODIFICATION EXAMPLE

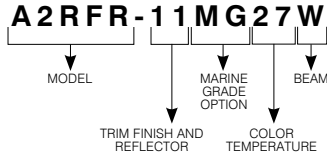

TRIM WITH FLANGE ORDERING CODE **A2RFR**

MODEL	TRIM AND REFLECTOR FINISHES	MARINE GRADE	COLOR TEMPERATURES	BEAMS
A2RFR				
A2RFR	-03 24K Gold Plated	MG (optional)	27 2,700K	M Narrow Flood (25°)
	-04 Chrome	May be applied	30 3,000K	W Flood (44°)
	-04BR Brushed Chrome	on finishes:	35 3,500K	
	-11 Matte White	-11, -22	40 4,000K	
	-12BR Brushed Nickel			
	-13 Satin Nickel			
	-17 Antique Nickel			
	-22 Matte Black			

FLANGELESS TRIM OPTION CODIFICATION EXAMPLE

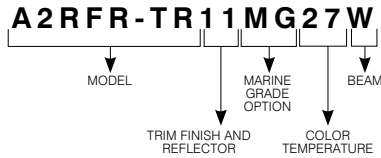

FLANGELESS TRIM OPTION ORDERING CODE **A2RFR-TR** (see next page for mud-in-plate ordering code)

MODEL	REFLECTOR FINISHES	MARINE GRADE	COLOR TEMPERATURES	BEAMS
A2RFR-TR				
A2RFR-TR	03 24K Gold Plated	MG (optional)	27 2,700K	M Narrow Flood (25°)
	04 Chrome	May be applied	30 3,000K	W Flood (44°)
	04BR Brushed Chrome	on finishes:	35 3,500K	
	11 Matte White	11 and 22	40 4,000K	
	12BR Brushed Nickel			
	13 Satin Nickel			
	17 Antique Nickel			
	22 Matte Black			

SPECIFICATION SHEET

Ardito LED - A2RFR

2-1/2" Series**Ultra-Thin Profile Round Regressed Trim****ORDERING CODE for replacement lenses and reflectors**

For future on-site modifications of the light distribution.

Lenses (to modify light diffusion)

Clear: **103584** (included) Prismatic: **103095**
 Frosted: **316228** Honeycombs: **103089**
 Linear: **103092**
 Solite: **104038**

Reflectors (to modify the beam angle)

For a Narrow Flood: **103901**
 For a Flood: **103902**

ORDERING CODE for Mud-in-Plate**MIPA2R**

Consult housing specification sheet for more details.

CONTRASTE

1009, rue du Parc Industriel
 Lévis (Québec) G6Z 1C5 Canada
 Tel.: 1-888-839-4624
 Fax.: 1-877-839-7057
 contrastlighting.com
 info@contrastlighting.com

© 2017 Contrast Lighting M.L. Inc.
 All rights reserved

Contrast Lighting M.L. Inc. reserves the right to make changes in specifications and/or to discontinue any product at any time without notice or obligation and will not be liable for any consequences resulting from the use of this publication.