

# Ardito

## 2-1/2" Series LED New Construction Housing

NWA2RV1 - NWA2SV1

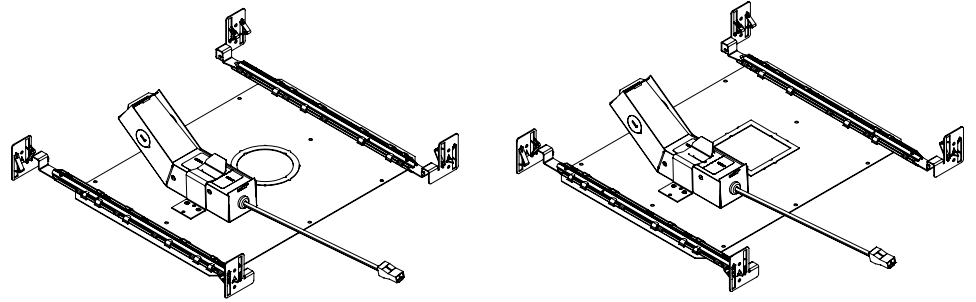

### Section 1: Installation Mounting Plate

#### ATTENTION

Required clearance beyond ceiling level is **5" (127 mm)** for flanged trim and **7" (178 mm)** for flangeless trim. This measure includes ceiling material.

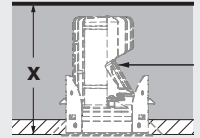

1. For the flangeless models, remove the exterior knockout (see below).

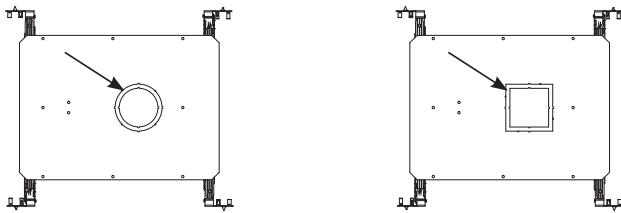

2. Locate position of mounting plate and fasten to the wood joist (or other ceiling type) with the adjustable mounting bars (10" (254 mm) to 24-1/2" (622 mm)).

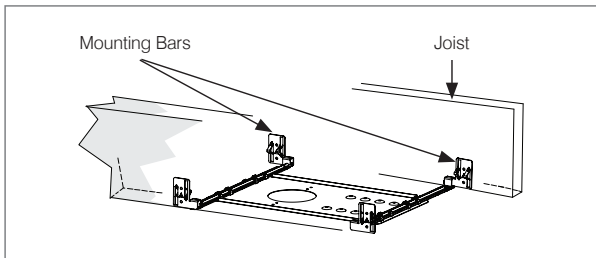

3. To shorten the bars to 10" (254 mm), remove bars and cut off at the notch (see adjustable mounting bars detail view).

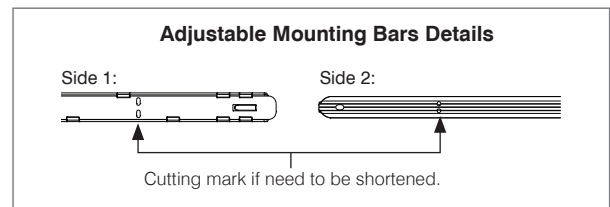

4. Once the correct bar length is known, press tabs to lock the mounting bars to the plate. Using pliers, tighten the U-shaped hooks on the T-bars (if applicable).

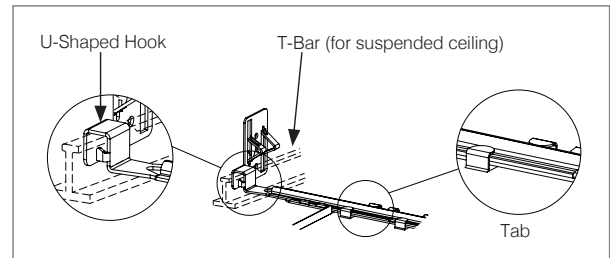

### Section 2: Connecting Junction Box and Housing Installation

1. **SHUT OFF THE ELECTRICAL SUPPLY AT SOURCE.**
2. Bring the electrical wiring to the junction box, according to your local electrical code.
3. Press on the junction box cover latch **(2)** to open the junction box cover **(1)**.

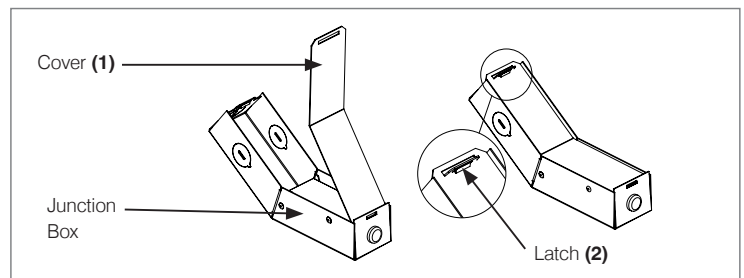

- Insert the 120/277V supply lead through the knockout in the junction box. Make the electrical connections according to the wire colors: White/White, Black/Black, Green/Green and 0-10V dimmers if needed (see wiring diagram).

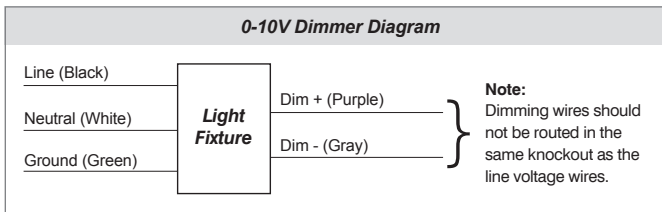
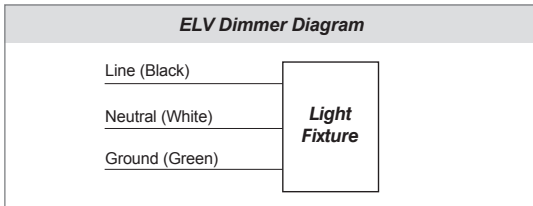
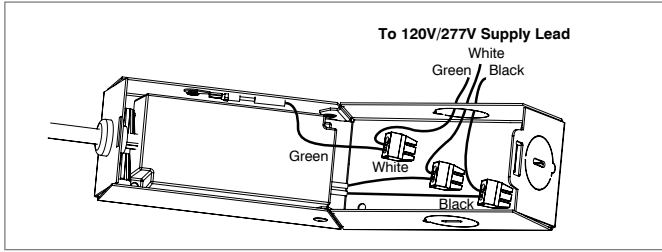

- Close the junction box cover (1) by pressing at the center of the cover. Make sure that it is properly closed.

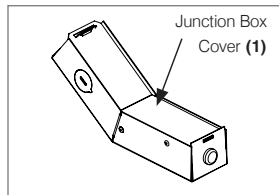

- Insert the junction box onto the new construction mounting plate using the label on the top of the junction box as guide to align the fixation support to the proper location.

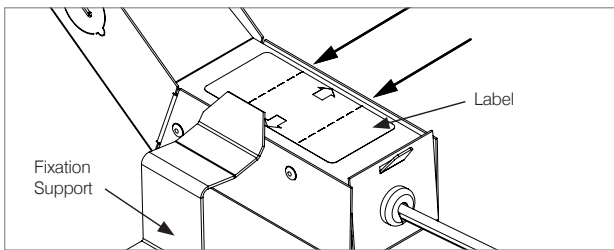

- Insert the junction box inside the fixation support until you hear a click.

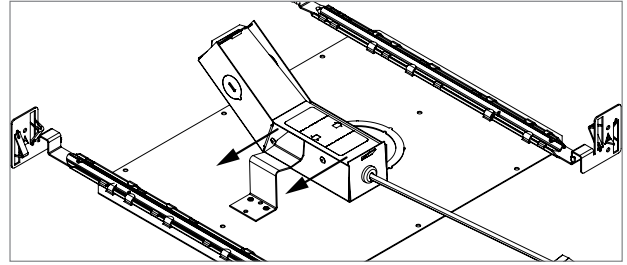

- Complete installation. Refer to the installation sheet of the chosen trim

**CEILING CUTOUT**

**IMPORTANT:** As the side trim is very thin and narrow, the edges of the hole must be clear, precise and without notches so that the trim fits perfectly in the ceiling.

**Note:** For square trim, it is strongly recommended to use the cardboard drilling template included with the trim. A reusable steel cutout template is also offered as an option (**TEMP-SQ**).

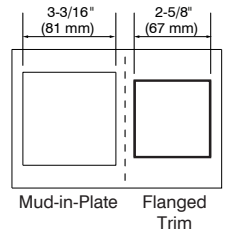

**Cutting diameter:**

Flanged Round Trim:  $\varnothing$  2-5/8" (67 mm)  
 Flanged Square Trim: 2-5/8" (67 mm) x 2-5/8" (67 mm)

Flangeless Round Trim:  $\varnothing$  3-3/16" (81 mm)  
 Flangeless Square Trim: 3-3/16" (81 mm) x 3-3/16" (81 mm)

**NOTE**

To uninstall housing once the ceiling is closed, pull the cable to dislodge the junction box.



Please keep these instructions for future reference.



**WARNING**

The use of other company's (non-Contraste) products or components (ex. trims) in conjunction with Contrast Lighting M.L. Inc. products may not be covered by UL approvals, and could be hazardous. Such use automatically voids all Contrast Lighting M.L. Inc. warranty and responsibility of these products.

**Due to constant evolution of dimmers we must test them regularly. We invite you to frequently visit our Web site to find our dimmer compatibility list: [www.contrastlighting.com](http://www.contrastlighting.com)**



**WARNING: RISK OF FIRE**

Most dwellings built before 1985 have supply wires rated 60° C. Consult a qualified electrician before installing.

**WARRANTY:** CONTRAST LIGHTING M. L. INC. guarantees the components against manufacturing defects for a period of one (1) year, under normal use with proof of purchase. The obligation of the manufacturer consists in the cost of the components and does not cover the cost of labor and transport for replacement. For all claims, please contact your local supplier. See our Web site for additional warranty details. **Note:** 5-year warranty on driver and LED module.

**CONTRASTE**