

# Air Tight URBAï New Construction Housing

SUITABLE FOR DAMP LOCATION / WET LOCATION WITH SHOWER TRIM

For use in insulated material — “IC” Type (except polyurethane)

NWUR3-120D1, NWUR3-120E1, NWUR3-277D1, NWUR3-UV1, NWUR4-120D1, NWUR4-120E1, NWUR4-277D1, NWUR4-UV1

“NON-IC” Type

NWUR3-120D2, NWUR3-120E2, NWUR3-120EB2, NWUR3-2772, NWUR3-277D2, NWUR3-UV2  
NWUR4-120D2, NWUR4-120E2, NWUR4-120EB2, NWUR4-2772, NWUR4-277D2, NWUR4-UV2

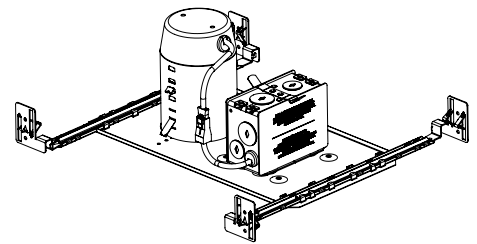

- SHUT OFF ELECTRICAL SUPPLY AT SOURCE.**
- Locate position of mounting frame and install before the ceiling material board. Fasten the mounting frame to the wood joists (or other ceiling type) with the adjustable mounting bars (10" to 24,5"). To shorten the bars to 10", remove bars and cut off at the notch (See adjustable mounting bars detail view).
- Once the correct bar length is known, fold down and press tabs to lock the plate to the mounting bars. Using pliers, tighten the U-shaped hooks on the T-bars.

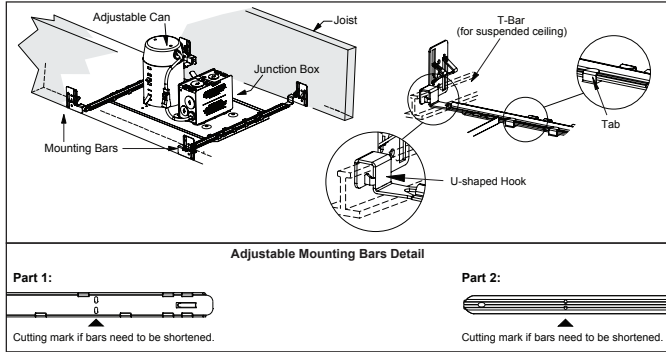

- Bring the electrical wiring to the housing junction box as per applicable local electrical codes. Open the junction box and connect the wires based on the diagrams below. Close the junction box.

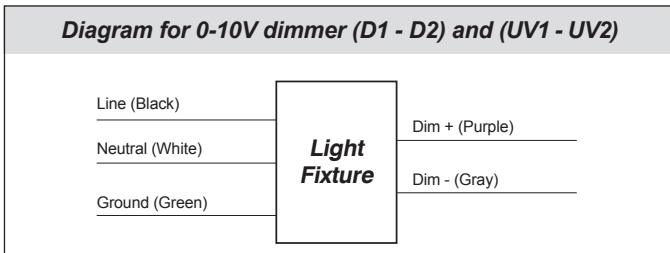
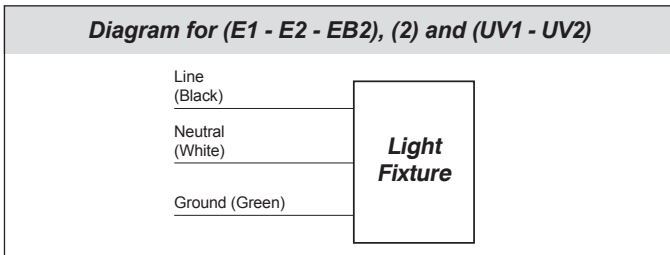

- Unlock the upper part of the can's captive hooks in order to release them.

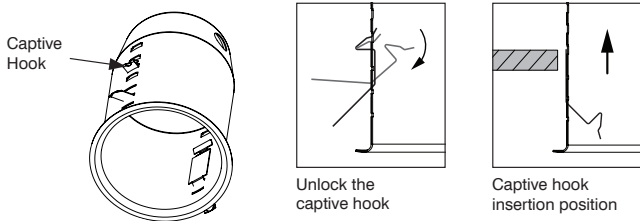

Please keep these installation instructions for future maintenance.

- Remove the can.
- Disconnect the can.
- Install the ceiling material and locate the center of each fixture on the ceiling material.
- Cut a hole to a diameter of:  
**NWUR3 (3-1/2") Series: Ø 3-5/8" (92 mm)**  
**NWUR4 (4") Series: Ø 4-1/4" (108 mm)**
- Connect the housing wires to the can wires and use the various adjustment holes on each side of the can and adjust the position of the captive hooks according to the ceiling thickness.

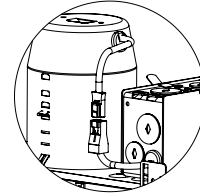

**Note:** Captive hooks are preinstalled for 1-3/8" (35 mm) ceiling thickness. Adjustment possibility up to a maximum of 2" (51 mm) ceiling thickness.



- Lock the captive hooks and make sure the hooks apply a pressure against the ceiling to maintain the can firmly in place.

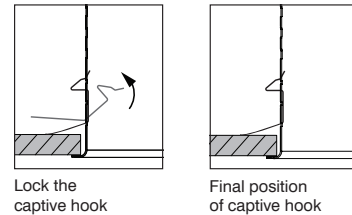

### INSTALLATION OF ALUMINUM TAPE

- Remove the film on the back of the included aluminum tape.
- Apply the aluminum tape inside the can covering entirely the hook openings on both sides of the can.
- Complete the installation.

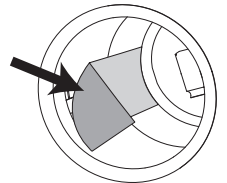

Connect the male and female connectors.

Push the connected wires in the pot, then push the trim in.

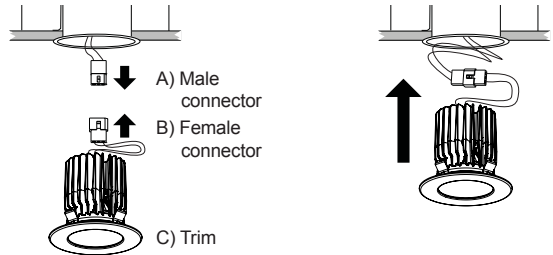

**WARNING**  
The use of other company's (non-Contraste) products or components (e. g. trims) in conjunction with Contrast Lighting M.L. Inc. products may not be covered by UL approvals and could be hazardous. Such use automatically voids all Contrast Lighting M.L. Inc. warranty and responsibility of these products.

**WARNING: RISK OF FIRE**  
Most dwellings built before 1985 have supply wires rated 60° C. Consult a qualified electrician before installing.

**Due to constant evolution of dimmers, we must test them regularly. We invite you to frequently visit our web site to find our dimmer compatibility list: [www.contrastlighting.com](http://www.contrastlighting.com)**

**WARRANTY:** CONTRAST LIGHTING M. L. INC. guarantees the components against manufacturing defects for a period of one (1) year, under normal use with proof of purchase. The obligation of the manufacturer consists in the cost of the components and does not cover the cost of labor and transport for replacement. For all claims, please contact your local supplier. See our Web site for additional warranty details. **Note:** 5-years warranty on driver and LED module.